

# PRODUCT MANUAL

ver. 2025.08.20

## SOLAR INVERTER

### SINUS PRO ULTRA PLUS

7000 24/230V 100A MPPT (60-500V)

12000 48/230V 120A MPPT (60-500V)



**VOLT**  
**POLSKA**

VOLT POLSKA Sp. z o.o.  
ul. Swiemirowska 3  
81-877 Sopot  
[www.voltpolska.pl](http://www.voltpolska.pl)

[pomoc@voltpolska.pl](mailto:pomoc@voltpolska.pl) | [hurt@voltpolska.pl](mailto:hurt@voltpolska.pl) | (58) 500 85 62

# Table Of Contents

<b>PRODUCT OVERVIEW</b> .....	<b>1</b>
<b>INSTALLATION</b> .....	<b>2</b>
Unpacking and Inspection .....	2
Preparation .....	2
Mounting the Unit.....	2
Battery Connection .....	3
AC Input/Output Connection .....	4
PV Connection.....	6
Final Assembly .....	7
<b>OPERATION</b> .....	<b>8</b>
Power ON/OFF .....	8
Operation and Display Panel.....	8
LCD Setting.....	9
<b>BATTERY EQUALIZATION</b> .....	<b>16</b>
<b>SETTING FOR LITHIUM BATTERY</b> .....	<b>18</b>
Fault Reference Code.....	23
Warning Indicator.....	24
<b>SPECIFICATIONS</b> .....	<b>25</b>
Table 1 Line Mode Specifications.....	25
Table 2 Inverter Mode Specifications .....	26
Table 3 Charge Mode Specifications.....	27
Table 4 General Specifications.....	27
<b>TROUBLE SHOOTING</b> .....	<b>28</b>
<b>Wi-Fi Plug Pro Quick Installation Guideline</b> .....	<b>29</b>

# PRODUCT OVERVIEW

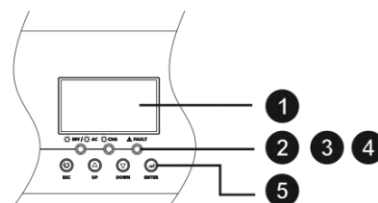
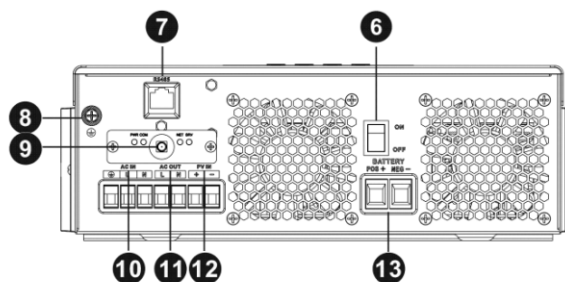
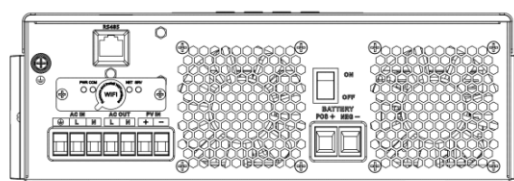
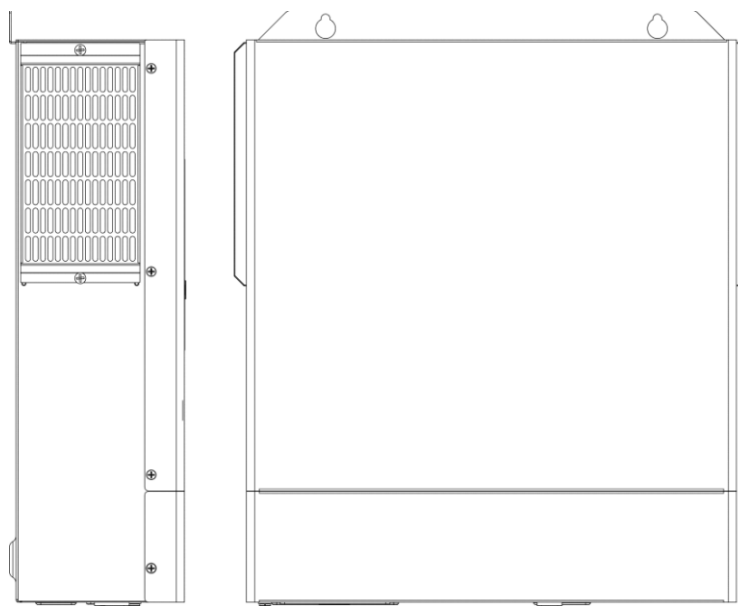

1. LCD display
2. Status indicator
3. Charging indicator
4. Fault indicator
5. Function buttons
6. Power on/off switch
7. RS485 communication port
8. Grounding
9. WiFi antenna port
10. AC input
11. AC output
12. PV input
13. Battery input

# INSTALLATION

## Unpacking and Inspection

Before installation, please inspect the unit. Be sure that nothing inside the package is damaged. You should have received the following items inside of package:

1. The unit x 1
2. User manual x 1
3. WiFi antenna x 1

## Preparation

Before connecting all wirings, please take off bottom cover by removing two screws as shown below.

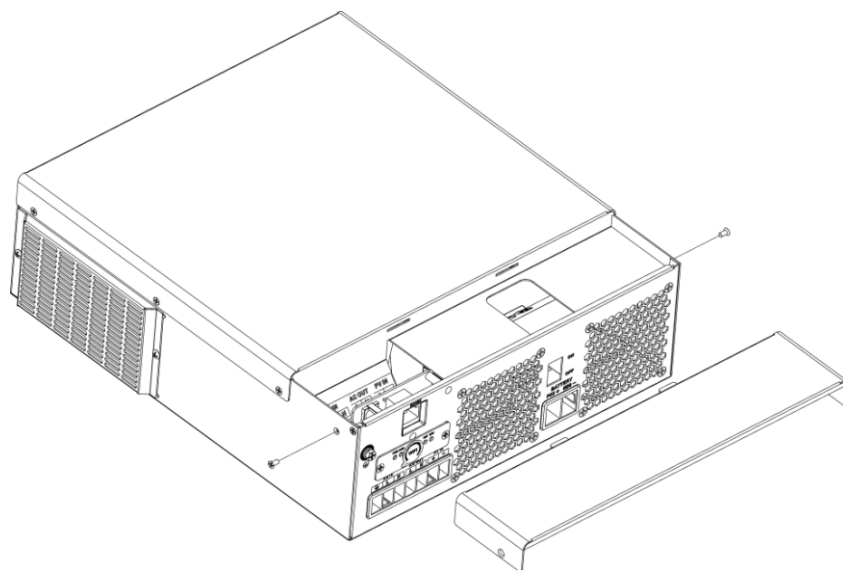

## Mounting the Unit

Consider the following points before selecting where to install:

1. Do not mount the inverter on flammable construction materials.
2. Mount on a solid surface
3. Install this inverter at eye level in order to allow the LCD display to be read at all times.
4. The ambient temperature should be between 0°C and 55°C to ensure optimal operation.
5. The recommended installation position is to be adhered to the wall vertically.
6. Be sure to keep other objects and surfaces as shown in the right diagram to guarantee sufficient heat dissipation and to have enough space for removing wires.

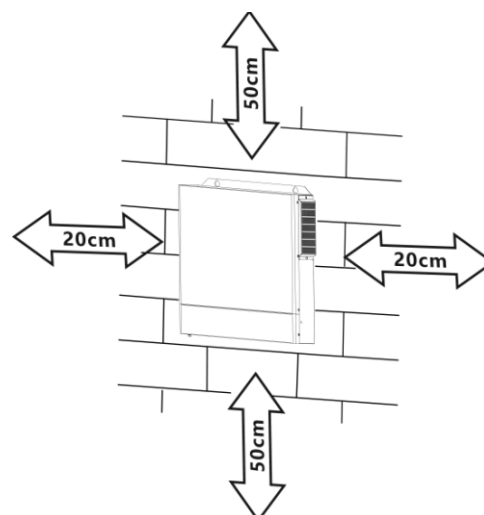

**SUITABLE FOR MOUNTING ON CONCRETE OR OTHER NON-COMBUSTIBLE SURFACE ONLY.**

Install the unit by screwing three screws. It's recommended to use M4 or M5 screws.

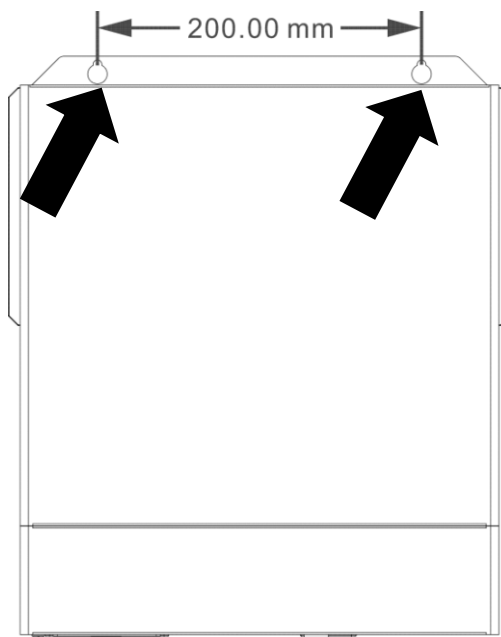

## Battery Connection

**CAUTION:** For safety operation and regulation compliance, it's requested to install a separate DC over-current protector or disconnect device between battery and inverter. It may not be requested to have a disconnect device in some applications, however, it's still requested to have over-current protection installed. Please refer to typical amperage in below table as required fuse or breaker size.

**WARNING!** All wiring must be performed by a qualified personnel.

**WARNING!** It's very important for system safety and efficient operation to use appropriate cable for battery connection. To reduce risk of injury, please use the proper recommended cable 、stripping length(L2) and tinning length(L1) as below.

### Stripping Length:

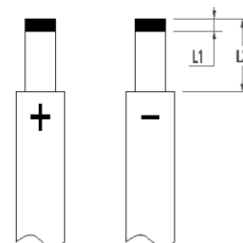

### Recommended battery cable 、stripping length (L2) and tinning length(L1):

Model	Maximum Amperage	Battery capacity	Wire Size	Cable mm <sup>2</sup>	L1 (mm)	L 2 (mm)	Torque Value
1500W-24	70A	100AH	6AWG	13.3	3	18	2~3 Nm
2500W-24	100A	100AH	4AWG	21.15	3	18	2~3 Nm
Other Models	137A	100AH	2AWG	38	3	18	2~3 Nm

Please follow below steps to implement battery connection:

1. Remove insulation sleeve 18 mm for positive and negative cables based on recommended stripping length.
2. Connect all battery packs as units requires. It's suggested to use recommended battery capacity.
3. Insert battery cable flatly into battery connector of inverter and make sure the bolts are tightened with torque of 2-3 Nm. Make sure polarity at both the battery and the inverter/charge is correctly connected and battery cables are tightly screwed to the battery connector.

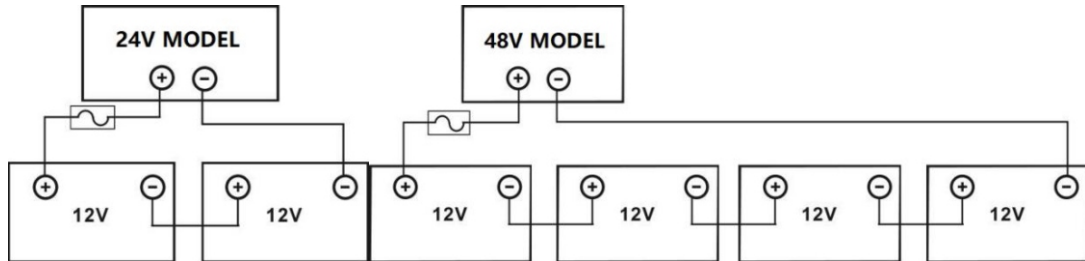
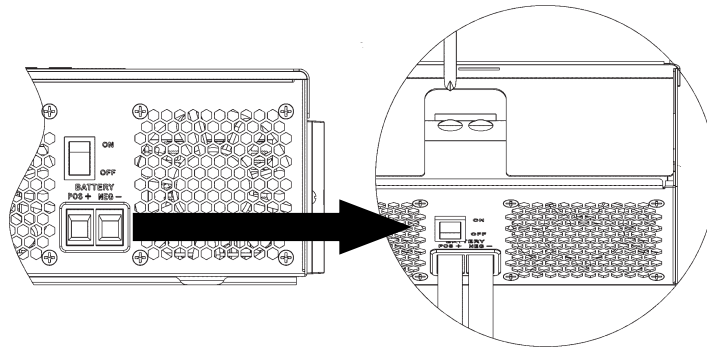

**WARNING: Shock Hazard**  
Installation must be performed with care due to high battery voltage in series.

**CAUTION!!** Do not place anything between the flat part of the inverter terminal. Otherwise, overheating may occur.  
**CAUTION!!** Do not apply anti-oxidant substance on the terminals before terminals are connected tightly.  
**CAUTION!!** Before making the final DC connection or closing DC breaker/disconnector, be sure positive (+) must be connected to positive (+) and negative (-) must be connected to negative (-).

## AC Input/Output Connection

**CAUTION!!** Before connecting to AC input power source, please install a **separate** AC breaker between inverter and AC input power source. This will ensure the inverter can be securely disconnected during maintenance and fully protected from over current of AC input. The recommended spec of AC breaker is 50A.

**CAUTION!!** There are two terminal blocks with "IN" and "OUT" markings. Please do NOT mis-connect input and output connectors.

**WARNING!** All wiring must be performed by a qualified personnel.

**WARNING!** It's very important for system safety and efficient operation to use appropriate cable for AC input connection. To reduce risk of injury, please use the proper recommended cable size as below.

### Suggested cable requirement for AC wires

Model	Gauge	Torque Value
1.5KVA	12AWG	1.4~ 1.6Nm
2.5KVA/3.5KVA	10AWG	1.4~ 1.6Nm
5.5KVA/6.2KVA	8 AWG	1.4~ 1.6Nm

Please follow below steps to implement AC input/output connection:

1. Before making AC input/output connection, be sure to open DC protector or disconnector first.
2. Remove insulation sleeve 10mm for six conductors. And shorten phase L and neutral conductor N 3 mm.
3. Insert AC input wires according to polarities indicated on terminal block and tighten the terminal screws. Be sure to connect PE protective conductor (⊕) first.

⊕→**Ground (yellow-green)**

L→**LINE (brown or black)**

N→**Neutral (blue)**

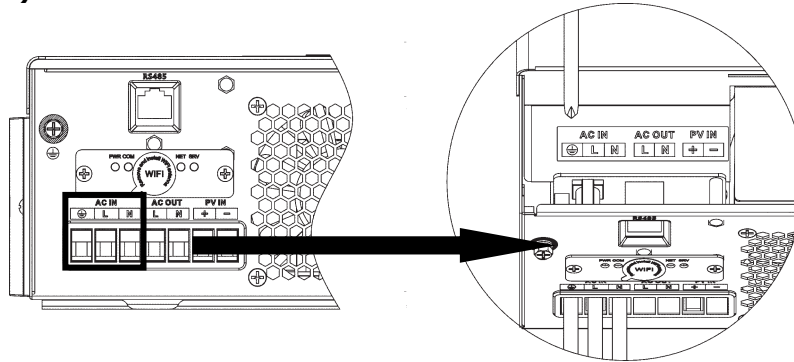

**WARNING:**

Be sure that AC power source is disconnected before attempting to hardwire it to the unit.

4. Then, insert AC output wires according to polarities indicated on terminal block and tighten terminal screws. Be sure to connect PE protective conductor (⊕) first.

⊕→**Ground (yellow-green)**

L→**LINE (brown or black)**

N→**Neutral (blue)**

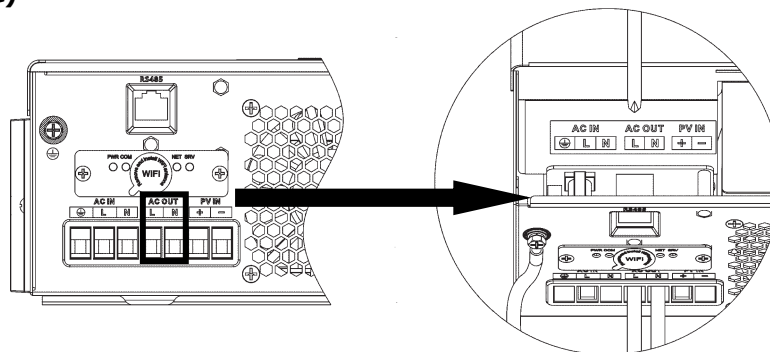

5. Make sure the wires are securely connected.

**CAUTION:** Appliances such as air conditioner are required at least 2~3 minutes to restart because it's required to have enough time to balance refrigerant gas inside of circuits. If a power shortage occurs and recovers in a short time, it will cause damage to your connected appliances. To prevent this kind of damage, please check manufacturer of air conditioner if it's equipped with time-delay function before installation. Otherwise, this inverter/charger will trig overload fault and cut off output to protect your appliance but sometimes it still causes internal damage to the air conditioner.

## PV Connection

**CAUTION:** Before connecting to PV modules, please install separately a DC circuit breaker between inverter and PV modules.

**WARNING!** All wiring must be performed by a qualified personnel.

**WARNING!** It's very important for system safety and efficient operation to use appropriate cable for PV module connection. To reduce risk of injury, please use the proper recommended cable size as below.

Model	Typical Amperage	Cable Size	Torque
1.5KVA	15A	12 AWG	1.4~1.6 Nm
2.5KVA	15A	12 AWG	1.4~1.6 Nm
3.5KVA	15A	12 AWG	1.4~1.6 Nm
5.5KVA	18A	12 AWG	1.4~1.6 Nm
6.2KVA	27A	12 AWG	1.4~1.6 Nm

### PV Module Selection:

When selecting proper PV modules, please be sure to consider below parameters:

1. Open circuit Voltage (Voc) of PV modules not exceeds max. PV array open circuit voltage of inverter.
2. Open circuit Voltage (Voc) of PV modules should be higher than min. battery voltage.

Solar Charging Mode					
<b>INVERTER MODEL</b>	1.5KVA	2.5KVA	3.5KVA	5.5KVA	6.2KVA
<b>Max. PV Array Open Circuit Voltage</b>	500DC				
<b>PV Array MPPT Voltage Range</b>	60VDC~500VDC				
<b>Max. PV INPUT CURRENT</b>	15A	15A	15A	18A	27A

Take the 450Wp and 550Wp PV module as an example. After considering above two parameters, the recommended module configurations are listed in the table below.

Solar Panel Spec. (reference) - 450Wp - Vmp: 34.67Vdc - Imp: 13.82A - Voc: 41.25Vdc - Isc: 12.98A	SOLAR INPUT	Q'ty of panels	Total input power	Inverter Model
	2 pcs in serial	2 pcs	900 W	1.5KVA-6.2KVA
	3 pcs in serial	3 pcs	1,350 W	
	4 pcs in serial	4 pcs	1,800 W	
	5 pcs in serial	5 pcs	2,250 W	
	6 pcs in serial	6 pcs	2,700 W	
	7 pcs in serial	7 pcs	3,150 W	
	8 pcs in serial	8 pcs	3,600 W	5.5KVA-6.2KVA
	9 pcs in serial	9 pcs	4,050 W	
	10 pcs in serial	10 pcs	4,500 W	
	11 pcs in serial	11 pcs	4,950 W	6.2KVA
	12 pcs in serial	12 pcs	5,400 W	
	6 pieces in serial and 2 sets in parallel	12 pcs	5,400 W	
7 pieces in serial and 2 sets in parallel	14 pcs	6,300 W		
Solar Panel Spec. (reference) - 550Wp - Vmp: 42.48Vdc - Imp: 12.95A - Voc: 50.32Vdc - Isc: 13.70A	SOLAR INPUT	Q'ty of panels	Total input power	Inverter Model
	2 pcs in serial	2 pcs	900 W	1.5KVA-6.2KVA
	3 pcs in serial	3 pcs	1,650 W	
	4 pcs in serial	4 pcs	2,200 W	
	5 pcs in serial	5 pcs	2,750 W	
	6 pcs in serial	6 pcs	3,300 W	
	7 pcs in serial	7 pcs	3,850 W	
	8 pcs in serial	8 pcs	4,400 W	5.5KVA-6.2KVA
	9 pcs in serial	9 pcs	4,950 W	
	4 pieces in serial and 2 sets in parallel	8 pcs	4,400 W	
	5 pieces in serial and 2 sets in parallel	10 pcs	5,500 W	
	6 pieces in serial and 2 sets in parallel	12 pcs	6,600 W	

## PV Module Wire Connection:

Please follow below steps to implement PV module connection:

1. Remove insulation sleeve 10 mm for positive and negative conductors
2. Check correct polarity of connection cable from PV modules and PV input connectors. Then, connect positive pole (+) of connection cable to positive pole (+) of PV input connector. Connect negative pole (-) of connection cable to negative pole (-) of PV input connector.

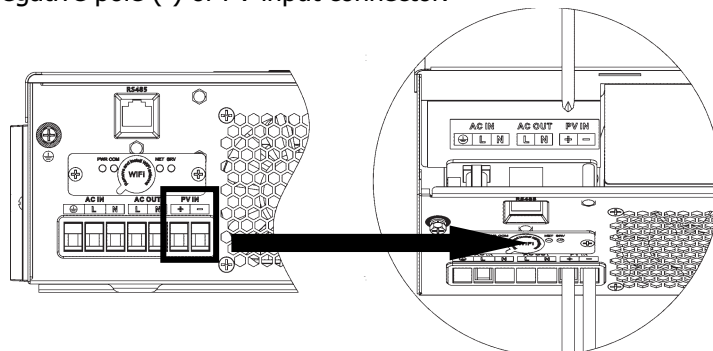
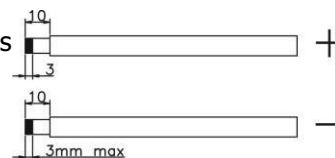

3. Make sure the wires are securely connected.

## Final Assembly

After connecting all wirings, please put bottom cover back by screwing two screws as shown below.

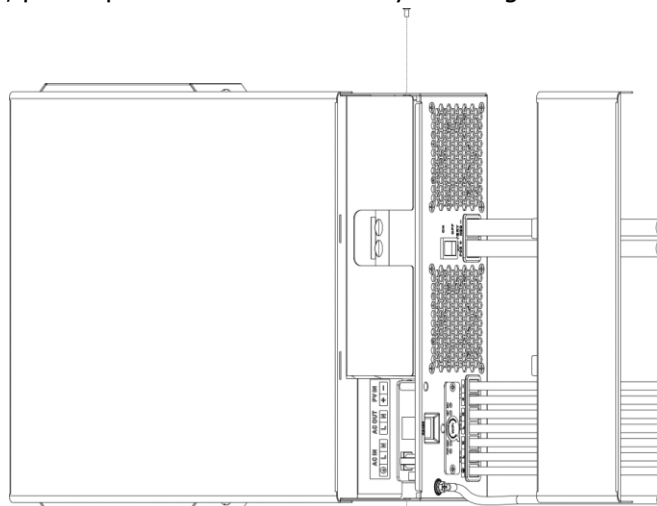

**The AC output of the inverter is used to directly supply power to the connected devices in the so-called island system.** It is forbidden to connect the AC output to the existing electrical system (even through differential current protection), especially to the phase, neutral N and differential current wires. Such a connection may result in reverse voltage applied to the inverter output. **Damage caused by such connection will result in loss of warranty.**

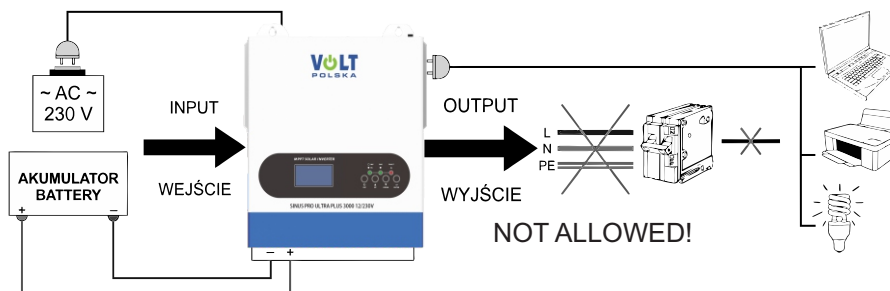

If interference from the mains occurs at the 230V AC input during PSU operation, the PSU will switch to battery operation (BATTERY MODE) for the duration of such interference in order to filter out the interference. After detecting a voltage without interference at the 230V AC input, the power supply will switch back to mains operation (NORMAL WORKING). This situation may occur several times in a short time interval (e.g.: 4-5 times switching within 10 seconds). This is due to an incorrect parameter of the power supply network in the form of a 50Hz frequency imbalance or an incorrect sine wave. The main reason may be heat pumps or on-grid photovoltaics plugged into the same power line (off the customer's grid). This is normal behavior of the inverter and does not in any way adversely affect the operation of the power supply itself and the devices connected to it.

# OPERATION

## Power ON/OFF

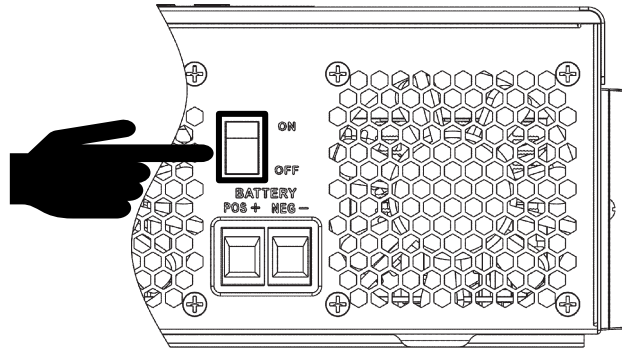

Once the unit has been properly installed and the batteries are connected well, simply press On/Off switch (located on the button of the case) to turn on the unit.

## Operation and Display Panel

The operation and display panel, shown in below chart, is on the front panel of the inverter . It includes three indicators, four function keys and a LCD display, indicating the operating status and input/output power information.

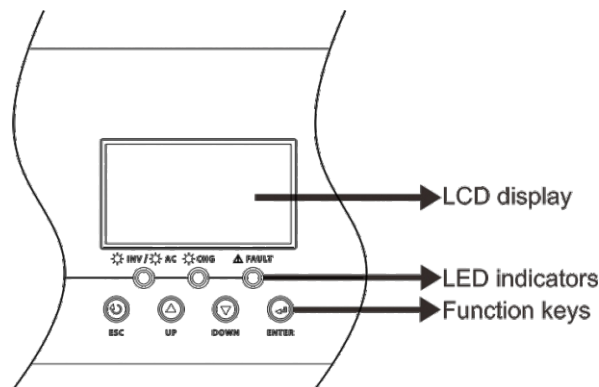

### LED Indicator

LED Indicator		Messages	
	Green	Solid On	Output is powered by utility in Line mode.
		Flashing	Output is powered by battery or PV in battery mode.
	Green	Solid On	Battery is fully charged.
		Flashing	Battery is charging.
	Red	Solid On	Fault occurs in the inverter.
		Flashing	Warning condition occurs in the inverter.

### Function Keys

Function Key	Description
ESC	To exit setting mode
UP	To go to previous selection
DOWN	To go to next selection
ENTER	To confirm the selection in setting mode or enter setting mode

## LCD Setting

After pressing and holding ENTER button for 3 seconds, the unit will enter setting mode. Press "UP" or "DOWN" button to select setting programs. And then, press "ENTER" button to confirm the selection or ESC button to exit.

### Setting Programs:





Program	Description	Selectable option	
01	Output source priority: To configure load power source priority	Utility first (default)	Utility will provide power to the loads as first priority. Solar and battery energy will provide power to the loads only when utility power is not available.
		Solar first	Solar energy provides power to the loads as first priority. If solar energy is not sufficient to power all connected loads, battery energy will supply power the loads at the same time. Utility provides power to the loads only when any one condition happens: - Solar energy is not available - Battery voltage drops to either low-level warning voltage or the setting point in program 12.
		SBU priority	Solar energy provides power to the loads as first priority. If solar energy is not sufficient to power all connected loads, battery energy will supply power to the loads at the same time. Utility provides power to the loads only when battery voltage drops to either low-level warning voltage or the setting point in program 12.
		SUB priority	Solar energy is charged first and then power to the loads. If solar energy is not sufficient to power all connected loads, Utility energy will supply power to the loads at the same time.

**Whether or not the energy from PV is sufficient to power the loads, the inverter will draw some energy from the grid to prevent energy from being fed back into the AC grid. To completely eliminate energy consumption from the AC grid, it must be disconnected from the inverter.**

02	Maximum charging current: To configure total charging current for solar and utility chargers. (Max. charging current = utility charging current + solar charging current)	60A (default) 02 60 <sup>A</sup>	If selected, acceptable charging current range will be from Max. AC charging current to Max. charging current of SPEC, but it shouldn't be less than the AC charging current (program 11)
03	AC input voltage range	Appliances (default) 03 APL	If selected, acceptable AC input voltage range will be within 90-280VAC.
		UPS 03 UPS	If selected, acceptable AC input voltage range will be within 170-280VAC.
		Generator 03 GNT	If selected, acceptable AC input voltage range will be within 170-280VAC and compatible with generators.  Note: Because generators are unstable, maybe the output of inverter will be unstable too.
05	Battery type	AGM (default) 05 AGM	Flooded 05 FLD
		User-Defined 05 USE	If "User-Defined" is selected, battery charge voltage and low DC cut-off voltage can be set up in program 26, 27 and 29.
		05 LI2	Support PYLON US2000 Protocol 3.5 Version
		05 LI4	Standard communication Protocol form inverter supplier
		Lithium battery without communication 05 LI6	If "LIB" is selected, the battery default value is fit for lithium battery without communication battery charge voltage and low DC cut-off voltage can be set up in program 26,27 and 29.

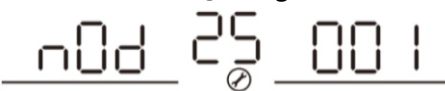
06	Auto restart when overload occurs	Restart disable 06 Lfd	Restart enable (default) 06 LfE
07	Auto restart when over temperature occurs	Restart disable 07 Lfd	Restart enable (default) 07 LfE
08	Output voltage	220V 08 220 <sup>v</sup>	230V (default) 08 230 <sup>v</sup>
		240V 08 240 <sup>v</sup>	
09	Output frequency	50Hz (default) 09 50 <sup>Hz</sup>	60Hz 09 60 <sup>Hz</sup>
10	Auto bypass When selecting "auto", if the mains power is normal, it will automatically bypass, even if the switch is off.	manual(default) 10 nNL	auto 10 AL0
11	Maximum utility charging current	30A (default) 11 30A	
12	Setting voltage point back to utility source when selecting "SBU priority" or "Solar first" in program 01.	<b>48V models</b> (program 5 is not LIB):46V (default) Setting range is from 44.0V to 57.2V for 48v model, but the max setting value must be less than the value of program13.	
		<b>48V models</b> (program 5 is LIB):52V (default) Setting range is from 44.0V to 57.2V for 48v model, but the max setting value must be less than the value of program13.	
		<b>24V models</b> (program 5 is not LIB):23V (default) Setting range is from 22.0V to 28.6V for 24v model, but The max setting value must be less than the value of program13.	
13	Setting voltage point back to battery mode when selecting "SBU priority" or "Solar first" in program 01.	<b>24V models</b> (program 5 is LIB):26V (default) Setting range is from 22.0V to 28.6V for 24v model, but The max setting value must be less than the value of program13.	
		Battery fully charged (default) 13 <sup>BATT</sup> FUL	<b>48V models:</b> Setting range is from 48V to full (the value of program26-0.4V), but the max setting value must be more than the value of program12. <b>24V models:</b> Setting range is from 24V to full (the value of program26-0.4V), but the max setting value must be more than the value of program12.

16	Charger source priority: To configure charger source priority	If this inverter/charger is working in Line, Standby or Fault mode, charger source can be programmed as below:	
		Solar first 16 C50	Solar energy will charge battery as first priority. Utility will charge battery only when solar energy is not available.
		Solar and Utility (default) 16 SNU	Solar energy and utility will charge battery at the same time.
		Only Solar 16 050	Solar energy will be the only charger source no matter utility is available or not.
		If this inverter/charger is working in Battery mode, only solar energy can charge battery. Solar energy will charge battery if it's available and sufficient.	
18	Buzzer mode	Mode1 BU2 18 nd1	Buzzer mute
		Mode2 BU2 18 nd2	The buzzer sounds when the input source changes or there is a specific warning or fault
		Mode3 BU2 18 nd3	The buzzer sounds when there is a specific warning or fault
		Mode4(default) BU2 18 nd4	The buzzer sounds when there is a fault
19	Auto return to default display screen	Return to default display screen (default) 19 ESP	If selected, no matter how users switch display screen, it will automatically return to default display screen (Input voltage /output voltage) after no button is pressed for 1 minute.
		Stay at latest screen 19 BEP	If selected, the display screen will stay at latest screen user finally switches.
20	Backlight control	Backlight on (default) 20 LON	Backlight off 20 LOF
23	Overload bypass: When enabled, the unit will transfer to line mode if overload occurs in battery mode.	Bypass disable 23 byd	Bypass enable(default) 23 byE

25	Modbus ID Setting	Modbus ID Setting Range : 001(default)~247 	
26	Bulk charging voltage (C.V voltage)	If self-defined is selected in program 5, this program can be set up. But the setting value must be more than or equal the value of program27. Increment of each click is 0.1V. 24V models(program 5 is not Lib): Default 28.2V, setting range is from 24.0V to 31.0V , 24V models(program 5 is Lib): Default 28.2V, setting range is from 24.0V to 29.0V ,  48V models(program 5 is not Lib): Default 56.4V, setting range is from 48.0V to 62.0V , 48V models(program 5 is Lib): Default 56.4V, setting range is from 48.0V to 58.0V .	
27	Floating charging voltage	If self-defined is selected in program 5, this program can be set up. 24V models(program 5 is not Lib) default setting: 27.0V Setting range is from 24.0V to the value of program 26 24V models(program 5 is Lib) default setting: 28.2.0V Setting range is from 24.0V to the value of program 26  48V models(program 5 is not Lib) default setting: 54.0V Setting range is from 48.0V to the value of program 26 48V models(program 5 is Lib) default setting: 56.4.0V Setting range is from 48.0V to the value of program 26	
29	Low DC cut-off voltage	If self-defined is selected in program 5, this program can be set up. The setting value must be less than the value of program12. Increment of each click is 0.1V.Low DC cut-off voltage will be fixed to setting value no matter what percentage of load is connected. 24V models default(program 5 is not LIB) setting: 21.0v Setting range is from 20.0V to 27.0V 24V models default(program 5 is LIB) setting: 25.0v Setting range is from 20.0V to 27.0V 48V models default(program 5 is not LIB) setting: 42.0V Setting range is from 40.0V to 54.0V 48V models default(program 5 is LIB) setting: 50.0V Setting range is from 40.0V to 54.0V	
32	Bulk charging time (C.V stage)	Automatically (Default): 	If selected, inverter will judge this charging time automatically.
		5 min 	The setting range is from 5 min to 900 min. Increment of each click is 5 min.
		900 min 	
		If "USE" is selected in program 05, this program can be set up.	

33	Battery equalization	Battery equalization 33 EEN	Battery equalization disable (default) 33 EdS
		If "Flooded" or "User-Defined" is selected in program 05, this program can be set up.	

**ATTENTION! The Equalization function does not act as an electronic voltage balancer. It does not monitor the voltages of individual cells and cannot be used with lithium batteries (e.g., LiFePO<sub>4</sub>). In such cases, a suitable BMS or external voltage balancer must be used.**

34	Battery equalization voltage	<p>24V models default(program 5 is not Lib) setting is 29.2V . Setting range is from floating voltage ~ 31V. Increment of each click is 0.1V .</p> <p>24V models default(program 5 is Lib) setting is 29.2V. Setting range is from floating voltage ~ 29V. Increment of each click is 0.1V.</p> <p>48V models default(program 5 is not Lib) setting is 58.4V . Setting range is from floating voltage ~ 62V. Increment of each click is 0.1V .</p> <p>48V models default(program 5 is Lib) setting is 58.4V. Setting range is from floating voltage ~ 58V. Increment of each click is 0.1V.</p>	
35	Battery equalized time	60min (default) 35 60	Setting range is from 0 min to 900min.
36	Battery equalized timeout	120min (default) 36 120	Setting range is from 0min to 900 min.
37	Equalization interval	30days (default) 37 30d	Setting range is from 1 to 90 days.
39	Equalization activated immediately	Enable 39 AEN	Disable (default) 39 AdS
		<p>If equalization function is enabled in program 33, this program can be set up. If "Enable" is selected in this program, it's to activate battery equalization immediately and LCD main page will shows "E9". If "Disable" is selected, it will cancel equalization function until next activated equalization time arrives based on program 37 setting. At this time, "E9" will not be shown in LCD main page..</p>	
41	Automatic activation for lithium battery	AAE 4] nNL	Disable automatic activation (default)
		AAE 4] Ato	When the lithium battery is selected in Program 05 and the battery is not detected, the device automatically activates the lithium-ion battery. If you want to automatically activate the lithium-ion battery, you must restart the device.

42	Manual activation for lithium battery	nAt 42 NOP	Default: disable activation
		nAt 42 ACT	When a lithium battery is selected in Program 05 and the battery is not detected, if you want to activate the lithium-ion battery, you can select this option.
43	Setting SOC point back to utility source when selecting "SBU priority" or "Solar first" in program 01	43 BAT 050%	Default 50%, 5%~50% Settable, but the minimum setting value must be more than the value of program 45.
44	Setting SOC point back to battery mode when selecting "SBU priority" or "Solar first" in program 01	44 BAT 095%	Default 95%, 60%~100% Settable
45	Low DC cut-off SOC	45 BAT 020%	Default 20%, 3%~30% Settable, but the max setting value must be less than the value of program 43.
46	Maximum discharge current protection	ndC 46 OFF	Default OFF Disable current discharge current protection function
		ndC 46 500 <sup>A</sup>	Only available in Single model. When utility is available, it turns to utility model and battery discharge stops after the battery discharge current exceeded the setting value. When utility is unavailable, warning occurs and battery discharge lasts after the battery discharge current exceeded the setting value.
48	Lithium battery activation time	48 006	This feature is used to start (reactivate) a lithium battery that is completely discharged and unresponsive. In some cases, the battery needs a short activation pulse before it can start charging normally - this is what this option provides. You can set how long this pulse should last - from 6 to 300 seconds. The default setting is 6 seconds, which is usually enough for most situations. The value can be increased if the device is unable to wake up the battery at the default time.

# BATTERY EQUALIZATION

Equalization function is added into charge controller. It reverses the buildup of negative chemical effects like stratification, a condition where acid concentration is greater at the bottom of the battery than at the top. Equalization also helps to remove sulfate crystals that might have built up on the plates. If left unchecked, this condition, called sulfation, will reduce the overall capacity of the battery. Therefore, it's recommended to equalize battery periodically.

## How to Apply Equalization Function

You must enable battery equalization function in monitoring LCD setting program 33 first. Then, you may apply this function in device by either one of following methods:

1. Setting equalization interval in program 37.
2. Active equalization immediately in program 39.

## When to Equalize

In float stage, when the setting equalization interval (battery equalization cycle) is arrived, or equalization is active immediately, the controller will start to enter Equalize stage.

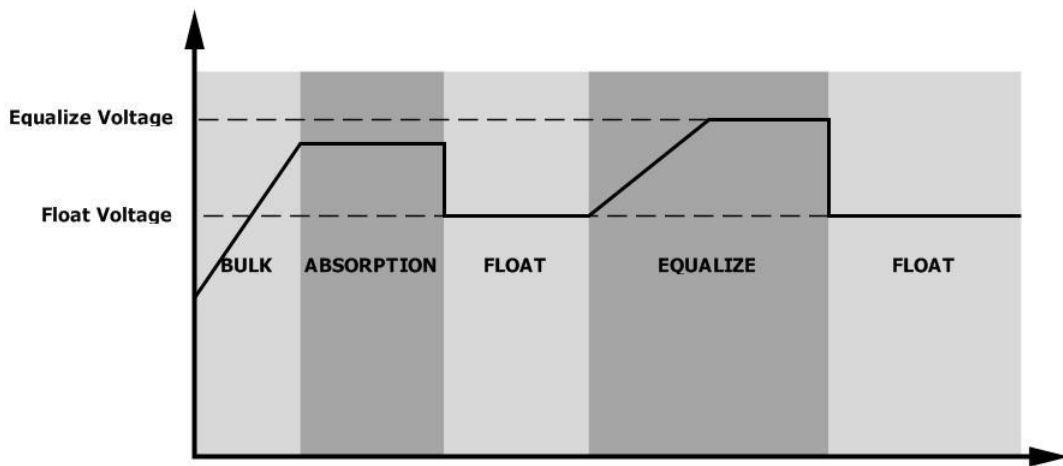

## Equalize charging time and timeout

In Equalize stage, the controller will supply power to charge battery as much as possible until battery voltage raises to battery equalization voltage. Then, constant-voltage regulation is applied to maintain battery voltage at the battery equalization voltage. The battery will remain in the Equalize stage until setting battery equalized time is arrived.

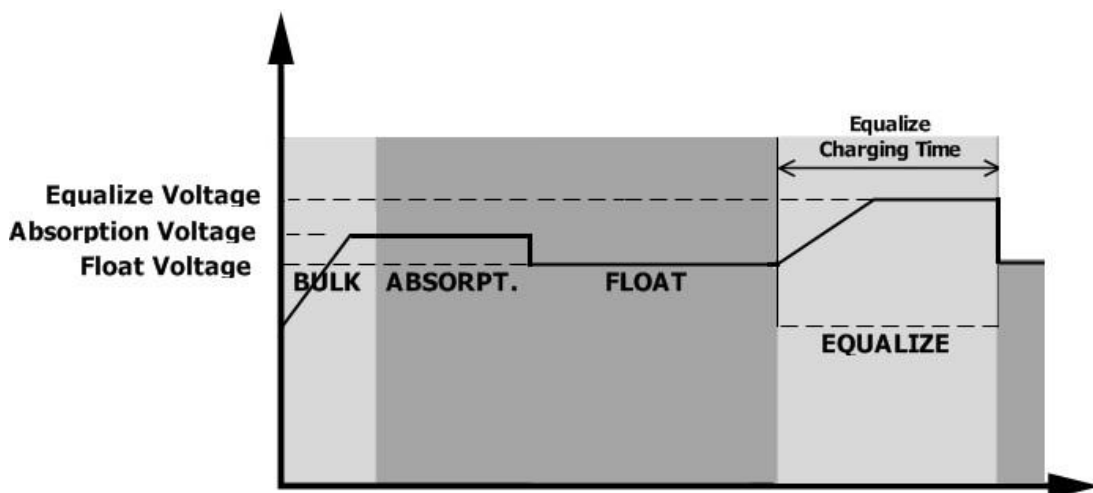

However, in Equalize stage, when battery equalized time is expired and battery voltage doesn't rise to battery equalization voltage point, the charge controller will extend the battery equalized time until battery voltage achieves battery equalization voltage. If battery voltage is still lower than battery equalization voltage when battery equalized timeout setting is over, the charge controller will stop equalization and return to float stage.

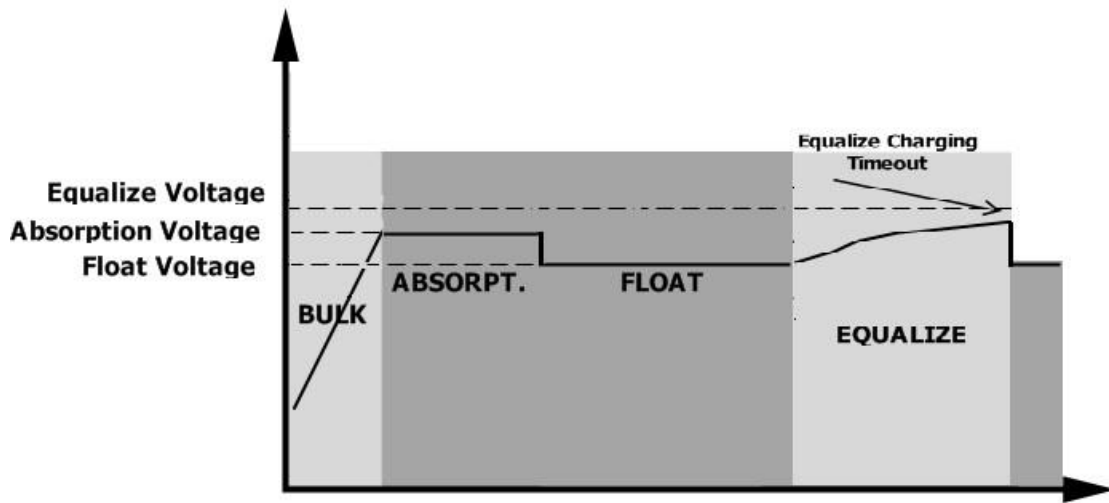

# SETTING FOR LITHIUM BATTERY

## Lithium Battery Connection

If choosing lithium battery for the inverter, you are allowed to use the lithium battery only which we have configured. There're two connectors on the lithium battery, RS485 port of BMS and power cable.

Please follow below steps to implement lithium battery connection:

- 1). Assemble battery terminal based on recommended battery cable and terminal size (same as Lead acid, see section Lead-acid Battery connection for details).
- 2). Connect the end of RS485 port of battery to BMS(RS485) communication port of inverter.

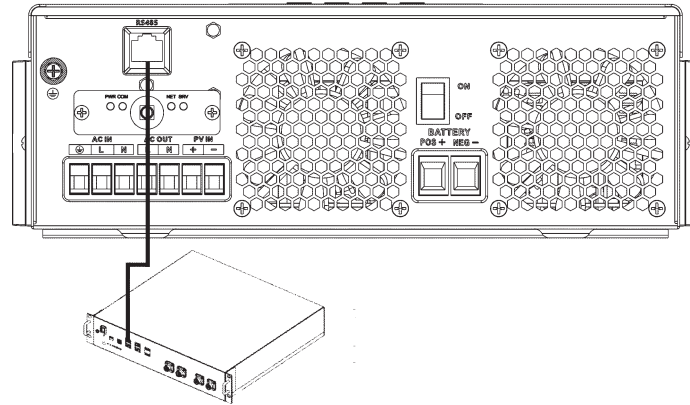

Fig 1

## Lithium battery communication and setting

if choosing lithium battery, make sure to connect the BMS communication cable between the battery and the inverter. This communication cable delivers information and signal between lithium battery and the inverter. This information is listed below:

Re-configure charging voltage, charging current and battery discharge cut-off voltage according to the lithium battery parameters.

Have the inverter start or stop charging according to the status of lithium battery.

### Connect the end of RS485 of battery to RS485 communication port of inverter

Make sure the lithium battery RS485 port connects to the inverter is Pin to Pin, the communication cable is inside of package and the inverter RS485 port pin assignment shown as below:

Pin number	RS485 Port
PIN1	RS485-B
PIN2	RS485-A
PIN7	RS485-A
PIN8	RS485-B

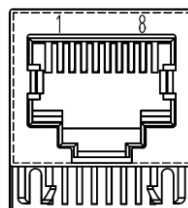

## LCD setting



After connecting, you need to finish and confirm some settings as follow:

- 1) Select program 05 as lithium battery type.
- 2) Confirm program 41/42/43/44/45 setting value.

**Note:** Program 43/44/45 are only available with successful communication, they will replace the Program 12/13/29 function, at the same time, program 12/13/29 become unavailable.

## LCD Display

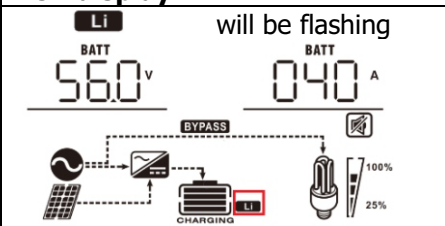
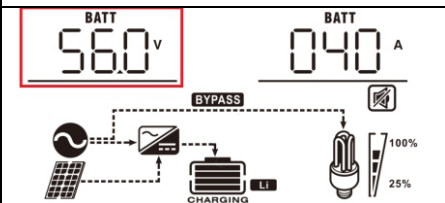
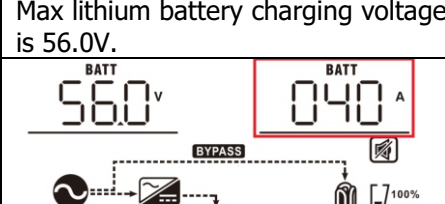
If communication between the inverter and battery is successful, there is some information showing on the LCD as follow:

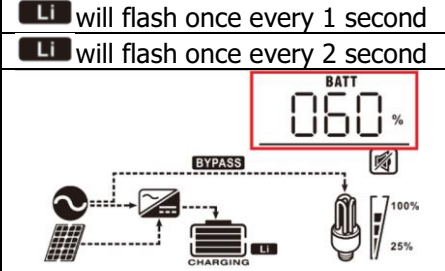
Item	Description	LCD display
1	Communication successful icon	 <p>will be flashing</p>
2	Max lithium battery charging voltage	 <p>Max lithium battery charging voltage is 56.0V.</p>
3	Max lithium battery charging current	 <p>Max lithium battery charging current is 40A.</p>
4	Lithium battery discharging is forbidden	
5	Lithium battery charging is forbidden	
6	Lithium battery SOC(%)	 <p>Lithium battery SOC is 63AH and 60%</p>

## Setting for PYLON US2000 lithium battery

1). PYLONTECH US2000 lithium battery setting:

Dip Switch: There are 4 Dip Switches that sets different baud rate and battery group address. If switch position is turned to the "OFF" position, it means "0". If switch position is turned to the "ON" position, it means "1".

Dip 1 is "ON" to represent the baud rate 9600.

Dip 2, 3 and 4 are reserved for battery group address.

Dip switch 2, 3 and 4 on master battery (first battery) are to set up or change the group address.

**NOTE:** "1" is upper position and "0" is bottom position.

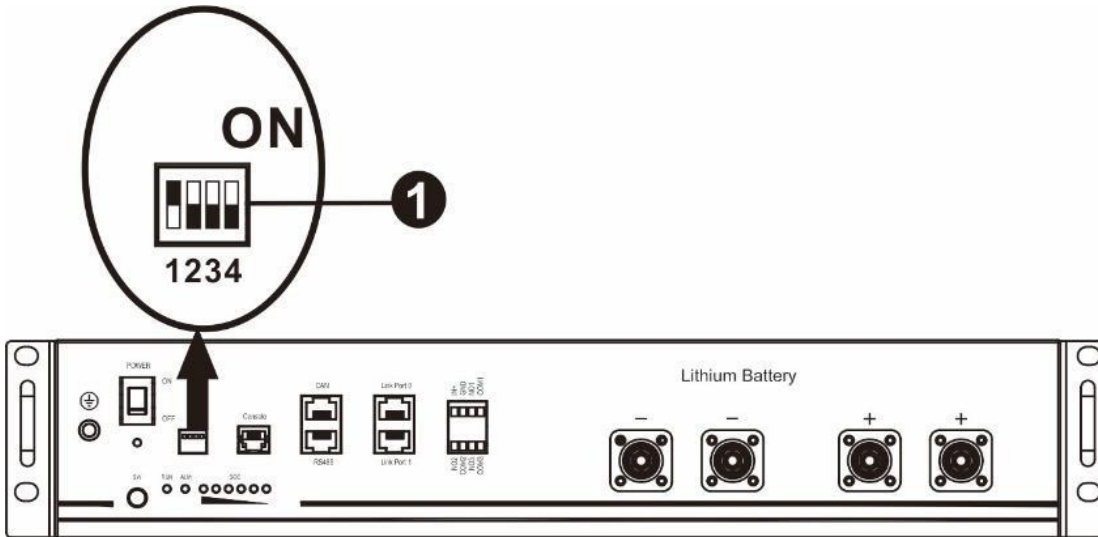

2). Process of install

Step 1. Use the RS485 cable to connect inverter and Lithium battery as Fig 1.

Step 2. Switch on Lithium battery.

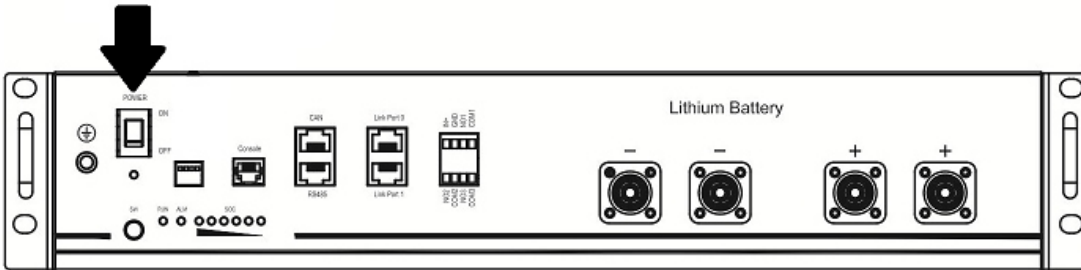

Step 3. Press more than three seconds to start Lithium battery, power output ready.

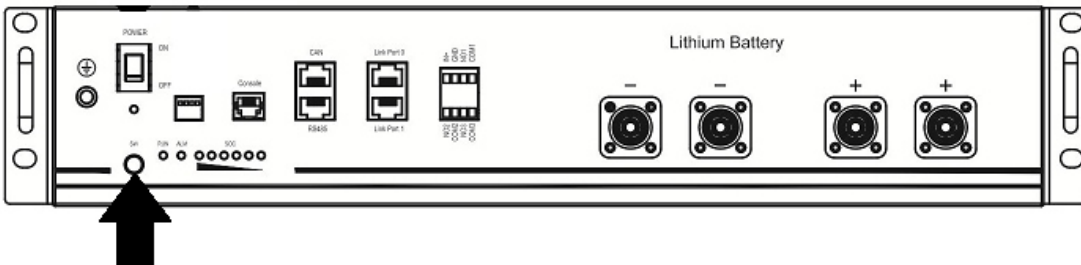

Step 4. Turn on the inverter.

Step 5. Be sure to select battery type as "Li2" in LCD program 5.

If communication between the inverter and battery is successful, the battery icon **Li** on LCD display will light

### Setting for lithium battery without communication

This suggestion is used for lithium battery application and avoid lithium battery BMS protection without communication, please finish the setting as follow:

1. Before starting setting, you must get the battery BMS specification:

- A. Max charging voltage
- B. Max charging current
- C. Discharging protection voltage

3. Set battery type as“ LIB”

05	Battery type	AGM (default) 05 AGn	Flooded 05 FLd
		<b>User-Defined</b> 05 USE	If “User-Defined” is selected, battery charge voltage and low DC cut-off voltage can be set up in program 26, 27 and 29.
		Lithium battery without communication 05 LIB	If “LIB” is selected, the battery default value is fit for lithium battery without communication battery charge voltage and low DC cut-off voltage can be set up in program 26,27 and 29.

3. Set C.V voltage as Max charging voltage of BMS-0.5V.

26	Bulk charging voltage (C.V voltage)	If self-defined is selected in program 5, this program can be set up. But the setting value must be more than or equal the value of program27. Increment of each click is 0.1V. 24V models: Default 28.2V, setting range is from 24.0V to 30.0V , 48V models: Default 56.4V, setting range is from 48.0V to 62.0V.
----	-------------------------------------	--

4. Set floating charging voltage as C.V voltage.

27	Floating charging voltage	If self-defined is selected in program 5, this program can be set up. 24V models default setting: 27.0V Setting range is from 24.0V to the value of program 26 48V models default setting: 54.0V Setting range is from 48.0V to the value of program 26
----	---------------------------	---

5. Set Low DC cut-off voltage  $\geq$ discharging protection voltage of BMS+2V .

29	Low DC cut-off voltage	<p>If self-defined is selected in program 5, this program can be set up. The setting value must be less than the value of program12. Increment of each click is 0.1V.Low DC cut-off voltage will be fixed to setting value no matter what percentage of load is connected.</p> <p>24V models default setting: 21.0v Setting range is from 20.0V to 27.0V</p> <p>48V models default setting: 42.0V Setting range is from 40.0V to 54.0V</p>
----	------------------------	--

6. Set Max charging current which must be less than the Max charging current of BMS.

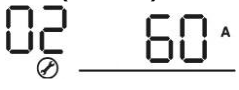
02	<p>Maximum charging current: To configure total charging current for solar and utility chargers. (Max. charging current = utility charging current + solar charging current)</p>	<p>60A (default)</p> 	<p>If selected, acceptable charging current range will be within 1- Max. charging current of SPEC, but it shouldn't be less than the AC charging current (program 11)</p>
----	--	--	---





















7. Setting voltage point back to utility source when selecting "SBU priority" or "Solar first" in program 01.The setting value must be  $\geq$ Low DC cut-off voltage+1V , or else the inverter will have a warning as battery voltage low.

12	Setting voltage point back to utility source when selecting "SBU priority" or "Solar first" in program 01.	<p><b>48V models:</b>46V (default) Setting range is from 44.0V to 57.2V for 48v model, but the max setting value must be less than the value of program13.</p>
		<p><b>24V models:</b>23V (default) Setting range is from 22.0V to 28.6V for 24v model, but The max setting value must be less than the value of program13.</p>

Remark:

- 1.you'd better to finish setting without turn on the inverter(just let the LCD show, no output);
- 2.when you finish setting, please restart the inverter.

## Fault Reference Code

Fault Code	Fault Event	Icon on
01	Over temperature of inverter module	
02	Over temperature of DCDC module	
03	Battery voltage is too high	
04	Over temperature of PV module	
05	Output short circuited.	
06	Output voltage is too high.	
07	Overload time out	
08	Bus voltage is too high	
09	Bus soft start failed	
10	PV over current	
11	PV over voltage	
12	DCDC over current	
13	Over current or surge	
14	Bus voltage is too low	
15	Inverter failed (Self-checking)	
18	Op current offset is too high	
19	Inverter current offset is too high	
20	DC/DC current offset is too high	
21	PV current offset is too high	
22	Output voltage is too low	
23	Inverter negative power	

## Warning Indicator

Warning Code	Warning Event	Audible Alarm	Icon flashing
02	Temperature is too High	Beep three times every second	
04	Low battery	Beep once every second	
07	Overload	Beep once every 0.5 second	
10	Output power derating	Beep twice every 3 seconds	
14	Fan blocked	None	
15	PV energy is low	Beep twice every 3 seconds	
19	Lithium Battery communication is failed	Beep once every 0.5 second	
21	Lithium Battery over current	None	
E9	Battery equalization	None	
bP	Battery is not connected	None	

# SPECIFICATIONS

**Table 1 Line Mode Specifications**

INVERTER MODEL	1.5KVA	2.5KVA	3.5KVA	5.5KVA	6.2KVA
<b>Input Voltage Waveform</b>	Sinusoidal (utility or generator)				
<b>Nominal Input Voltage</b>	230Vac				
<b>Low Loss Voltage</b>	170Vac±7V (UPS) 90Vac±7V (Appliances)				
<b>Low Loss Return Voltage</b>	180Vac±7V (UPS); 100Vac±7V (Appliances)				
<b>High Loss Voltage</b>	280Vac±7V				
<b>High Loss Return Voltage</b>	270Vac±7V				
<b>Max AC Input Voltage</b>	300Vac				
<b>Nominal Input Frequency</b>	50Hz / 60Hz (Auto detection)				
<b>Low Loss Frequency</b>	40±1Hz				
<b>Low Loss Return Frequency</b>	42±1Hz				
<b>High Loss Frequency</b>	65±1Hz				
<b>High Loss Return Frequency</b>	63±1Hz				
<b>Output Short Circuit Protection</b>	Battery mode: Electronic Circuits				
<b>Efficiency (Line Mode)</b>	>95% ( Rated R load, battery full charged )				
<b>Transfer Time</b>	10ms typical (UPS); 20ms typical (Appliances)				
<p><b>Output power derating:</b> When AC input voltage drops to 95V or 170V depending on models, the output power will be derated.</p>	<p>The graph illustrates the output power derating characteristics. The vertical axis represents Output Power, with a dashed line indicating the Rated Power level and another dashed line indicating 50% Power. The horizontal axis represents Input Voltage, with markers at 90V, 170V, and 280V. The power remains at 50% from 90V to 170V, then increases linearly to reach the Rated Power at 170V, and remains constant at the Rated Power level up to 280V.</p>				

**Table 2 Inverter Mode Specifications**

INVERTER MODEL	1.5KVA	2.5KVA	3.5KVA	5.5KVA	6.2KVA
<b>Rated Output Power</b>	1.5KVA 1.5KW	2.5KVA 2.5KW	3.5KVA 3.5KW	5.5KVA 5.5KW	6.2KVA 6.2KW
<b>Output Voltage Waveform</b>	Pure Sine Wave				
<b>Output Voltage Regulation</b>	230Vac±5%				
<b>Output Frequency</b>	50Hz or 60Hz				
<b>Peak Efficiency</b>	94%				
<b>Surge Capacity</b>	2* rated power for 5 seconds				
<b>Nominal DC Input Voltage</b>	24Vdc			48Vdc	
<b>Cold Start Voltage</b>	23.0Vdc			46.0Vdc	
<b>Low DC Warning Voltage</b> Just for AGM and Flooded @ load < 20% @ 20% ≤ load < 50% @ load ≥ 50%	22.0Vdc 21.4Vdc 20.2Vdc			44.0Vdc 42.8Vdc 40.4Vdc	
<b>Low DC Warning Return Voltage</b> Just for AGM and Flooded @ load < 20% @ 20% ≤ load < 50% @ load ≥ 50%	23.0Vdc 22.4Vdc 21.2Vdc			46.0Vdc 44.8Vdc 42.4Vdc	
<b>Low DC Cut-off Voltage</b> Just for AGM and Flooded @ load < 20% @ 20% ≤ load < 50% @ load ≥ 50%	21.0Vdc 20.4Vdc 19.2Vdc			42.0Vdc 40.8Vdc 38.4Vdc	

ATTENTION! Applies to the SINUS PRO ULTRA PLUS inverter series!

Sinus Pro Ultra Plus inverters communicate with the ULTRA-5 (LiFePO<sub>4</sub>) energy storage system via an RS485 bus using RJ-45 connectors. Use a straight-through cable – green, without markings. This cable connects pins 1:1 (pin1–pin1, pin2–pin2, etc.)

Do not use a crossover cable (“Inverter ↔ Battery”), which is designed for inverters of other series.

Connection:

Plug the first end of the RJ-45 cable into the RS485 port on the Sinus Pro Ultra Plus inverter (usually marked “RS485” on the side or bottom panel). Plug the other end into the RS485 port on the ULTRA-5 storage unit (on the back of the housing, marked “RS485” or “BMS”).

Inverter setting – program [05]

Enter the inverter's LCD configuration menu. Go to [05] – Battery type / Battery communication protocol and set the option: Li-2 = PYLON. Confirm and exit the menu. After setting, the value Li 2 should appear on the inverter LCD screen, which means that the PYLON protocol is active – compatible with ULTRA-5 storage units. On the energy storage unit, select the pylon protocol on the RS connector.

### Table 3 Charge Mode Specifications

Utility Charging Mode					
INVERTER MODEL	1.5KVA	2.5KVA	3.5KVA	5.5KVA	6.2KVA
Max Charging Current (PV+AC) (@ VI/P=230Vac)	60Amp	100Amp	100Amp	100Amp	120Amp
Max Charging Current (AC)(@ VI/P=230Vac)	60Amp	80Amp			
Bulk Charging Voltage	Flooded Battery	29.2Vdc		58.4Vdc	
	AGM / Gel Battery	28.2Vdc		56.4Vdc	
Floating Charging Voltage	27Vdc		54Vdc		
Overcharge Protection	32Vdc		63Vdc		
Charging Algorithm	3-Step				
Charging Curve	<p>The graph plots Battery Voltage (per cell) on the left y-axis and Charging Current (%) on the right y-axis against Time on the x-axis. The voltage curve (black) rises linearly in the Bulk stage, plateaus in the Absorption stage, and then slightly drops in the Maintenance stage. The current curve (red) is constant in the Bulk stage, then decays exponentially in the Absorption stage, and remains low in the Maintenance stage. Key voltage levels are 2.25Vdc and 2.43Vdc (2.35Vdc). Time intervals T0 and T1 are indicated, with T1 = 10 * T0, minimum 10mins, maximum 8hrs.</p>				
Solar Input					
INVERTER MODEL	1.5KVA	2.5KVA	3.5KVA	5.5KVA	6.2KVA
Rated Power	2000W	3000W	4000W	5500W	6500W
Max. PV Array Open Circuit Voltage	500Vdc				
PV Array MPPT Voltage Range	60Vdc~500Vdc				
Max. Input Current	15A	15A	15A	18A	27A
Max. Charging Current(PV)	60A	100A	100A	100A	120A

### Table 4 General Specifications

INVERTER MODEL	1.5KVA	2.5KVA	3.5KVA	5.5KVA	6.2KVA
Operating Temperature Range	-10°C to 55°C				
Storage temperature	-15°C~ 60°C				
Humidity	5% to 95% Relative Humidity (Non-condensing)				
Dimension(D*W*H), mm	358x295x105			438x295x105	
Net Weight, kg	5.8	6.0	6.2	8.2	8.7

# TROUBLE SHOOTING

Problem	LCD/LED/Buzzer	Explanation / Possible cause	What to do
Unit shuts down automatically during startup process.	LCD/LEDs and buzzer will be active for 3 seconds and then complete off.	The battery voltage is too low	1. Re-charge battery. 2. Replace battery.
No response after power on.	No indication.	1. The battery voltage is far too low. 2. Battery polarity is connected reversed.	1. Check if batteries and the wiring are connected well. 2. Re-charge battery. 3. Replace battery.
Mains exist but the unit works in battery mode.	Input voltage is displayed as 0 on the LCD and green LED is flashing.	Input protector is tripped	Check if AC breaker is tripped and AC wiring is connected well.
	Green LED is flashing.	Insufficient quality of AC power. (Shore or Generator)	1. Check if AC wires are too thin and/or too long. 2. Check if generator (if applied) is working well or if input voltage range setting is correct. (UPS→Appliance)
	Green LED is flashing.	Set "Solar First" as the priority of output source.	Change output source priority to Utility first.
When the unit is turned on, internal relay is switched on and off repeatedly.	LCD display and LEDs are flashing	Battery is disconnected.	Check if battery wires are connected well.
Buzzer beeps continuously and red LED is on.	Fault code 07	Overload error. The inverter is overload 110% and time is up.	Reduce the connected load by switching off some equipment.
	Fault code 05	Output short circuited.	Check if wiring is connected well and remove abnormal load.
	Fault code 02	Internal temperature of inverter component is over 100°C.	Check whether the air flow of the unit is blocked or whether the ambient temperature is too high.
	Fault code 03	Battery is over-charged.	Return to repair center.
		The battery voltage is too high.	Check if spec and quantity of batteries are meet requirements.
	Fault code 06/22	Output abnormal (Inverter voltage below than 190Vac or is higher than 260Vac)	1. Reduce the connected load. 2. Return to repair center
	Fault code 08/09/15	Internal components failed.	Return to repair center.
	Fault code 13	Over current or surge.	Restart the unit, if the error happens again, please return to repair center.
	Fault code 14	Bus voltage is too low.	
Another fault code		If the wires is connected well, please return to repair center.	

# Wi-Fi Plug Pro Quick Installation Guideline

1.Schematic diagram of the Remove and install the wireless antenna

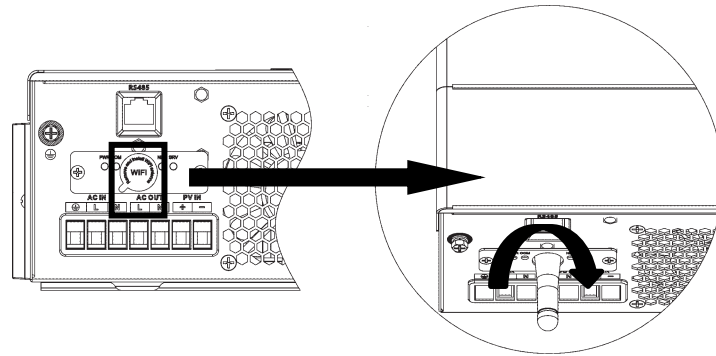

2.Wireless Router Connection

2.1 Download APP

① Scan the QR Code on the right side and download the APP



SmartESS(iOSS)



SmartESS(Android)

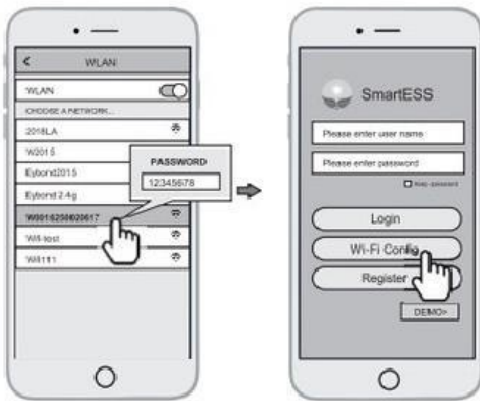

2.2 Connect Wi-Fi Datalogger

① Select the same number of Wi-Fi Plug Pro PN to connect on your phone WLAN.

(InitialPassword:12345678

② Open the APP,tap the Wi-Fi Config button to enter this page.

2.3 Network Setting

① Then tap the Network Setting button

② According to the prompts,type in the information to finish the network setting

③ After the Wi-Fi Plug Pro is restarted reconnect

the Wi-Fi which connected by step 1.1.

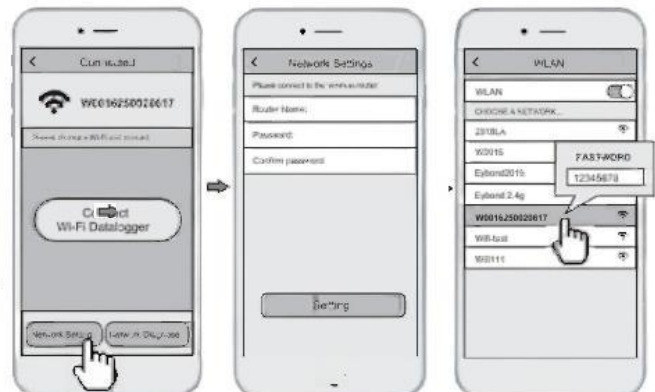

### 3. Create Account And Add Datalogger

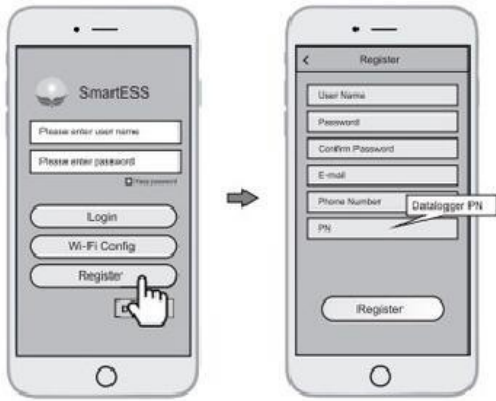

#### 3.1 Create Account

- ① Open the APP,tap the Register button to enter this page
- ② According to the prompts,type in the information to create an account.

#### 3.2 Add Datalogger

- ① Login the account and click the Datalogger button.Tap the "+" button on the top-right corner of the dataloager pag
- ② Scan the PN on the Wi-Fi Plug Pro,or input it
- ③ According to the prompts,type in the information to finish add datalogger

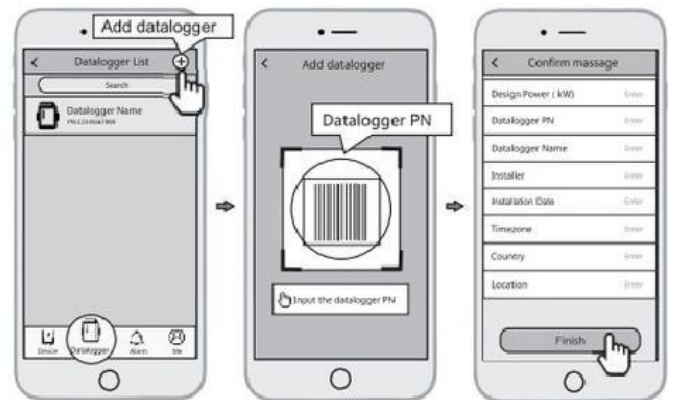

# WARRANTY CARD

<b>DATE OF PURCHASE</b>	
<b>SHIPPING ADDRESS</b>	
<b>SIGNATURE / STAMP</b>	
<b>DAMAGE DESCRIPTION</b>	
<b>SERVICE COMMENTS</b>	

FILL IN IF NEEDED

(\*) Cross incorrect

I agree to pay the cost of inverter repair due to:

\* expiration of the warranty period / \* warranty void

Before proceeding with the repair, service will inform by phone about the exact costs of the repair.

Please attach a copy of the purchase document (receipt or invoice) to the complaint.

The full regulations of service repairs can be found on our website [www.voltpolska.pl](http://www.voltpolska.pl)

## Proper disposal of the product (waste electrical and electronic equipment)

The marking placed on the product or in the texts related to it indicates that it should not be disposed of with other household waste at the end of its useful life. To avoid harmful effects to the environment and human health from uncontrolled disposal, please separate this product from other types of waste and recycle responsibly to promote the reuse of material resources as a continuing practice. For information on where and how to recycle this product in an environmentally safe manner, residential users should contact the retailer where they purchased the product, or their local government authority. Business users should contact their supplier and check the terms and conditions of their purchase contract. The product should not be disposed of with other commercial waste.

